

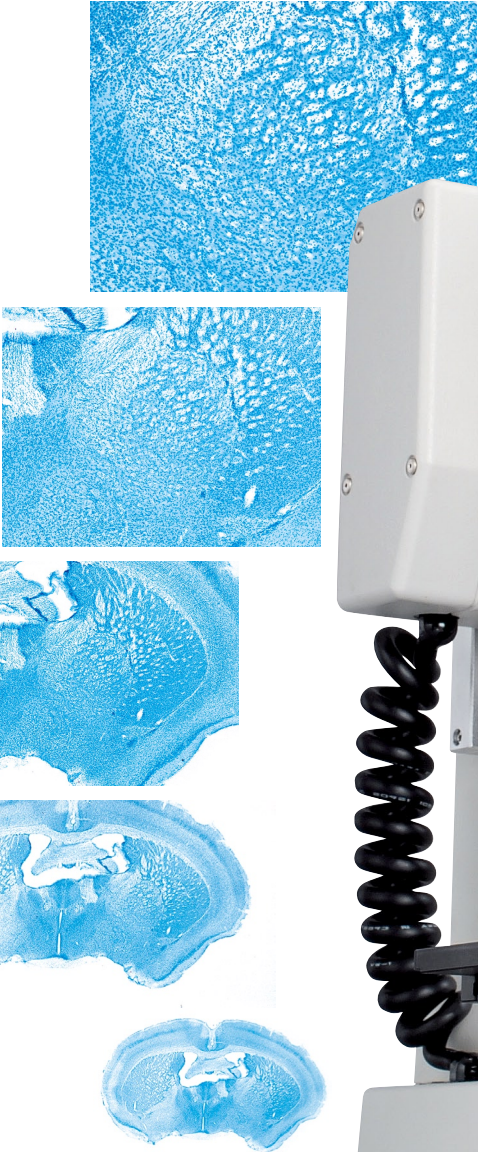

MOTORIZED MULTI-PURPOSE ZOOM MICROSCOPE
MULTIZOOM
AZ100M



New motorized multi-purpose zoom microscope, ideal for obtaining high-quality macro images



MOTORIZED MULTI-PURPOSE ZOOM MICROSCOPE
MULTIZOOM
AZ100M

Features motorized zoom and focus.
When combined with a Digital Sight camera,
microscope status data can be detected
automatically.



Introducing the AZ100M, which adds motorized focusing and zoom to the AZ100 universal macrozoom microscope and is capable of Nomarski DIC observation at low magnifications and a wide range of other illumination techniques. When combined with a Digital Sight camera, it is now possible to easily create all-in-focus images with scale bars that reflect the zoom magnification. The AZ100M, with its computer-controlled motorization, supports a broad range of applications including developmental biology and the study of biological structures.

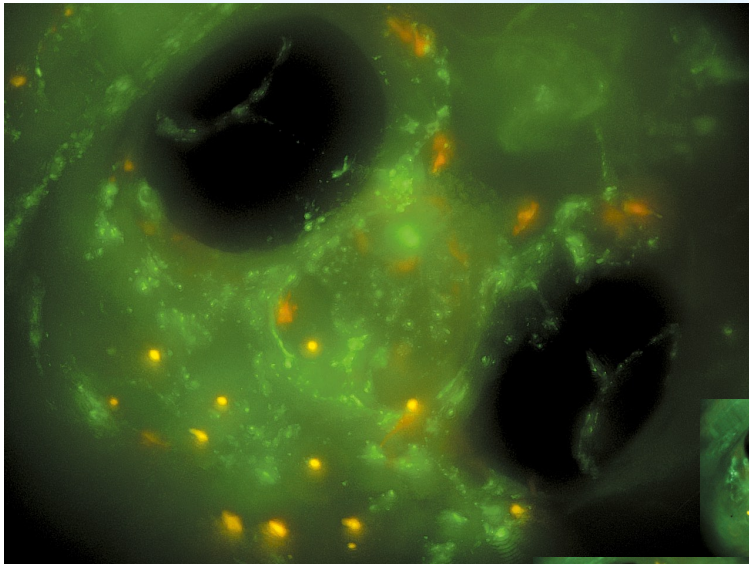

All-in-focus image created with NIS-Elements EDF program
Fluorescent images of transgenic Medaka (*Oryzias latipes*) embryo

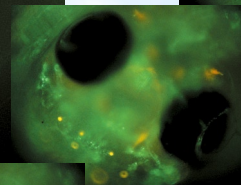
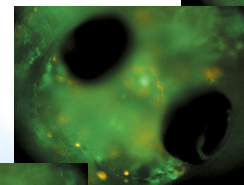
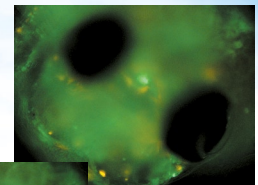

Different Z-axis images taken with motorized focus

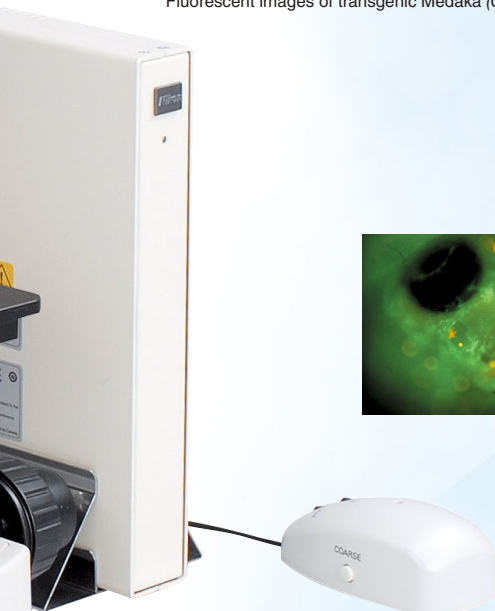
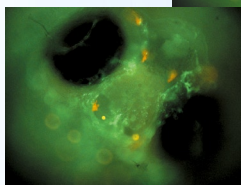
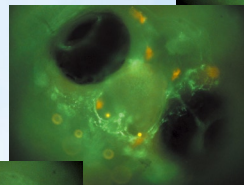
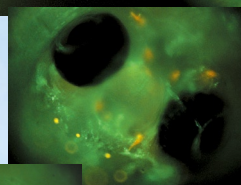

AZ100M combined with epi-fluorescence and diascope DIC accessories

MULTI-PURPOSE ZOOM MICROSCOPE
MULTIZOOM
AZ100

Nikon also offers the AZ100 with manual operation.

*Please refer to the AZ100 catalog for details.



AZ100 combined with diascope DIC accessories

Enjoy the advantages of both upright and stereoscopic

Wide range of observation magnifications

In combination with the triple nosepiece, the motorized 8x zoom function allows a best-in-class observation magnification ratio of 80:1. Five types of objective lens are available, at 0.5x, 1x, 2x, 4x, and 5x magnifications. Combined with 10x eyepieces, the AZ100M covers a total magnification of 5-400x in a single microscope with precision zooming in units of 0.1x.

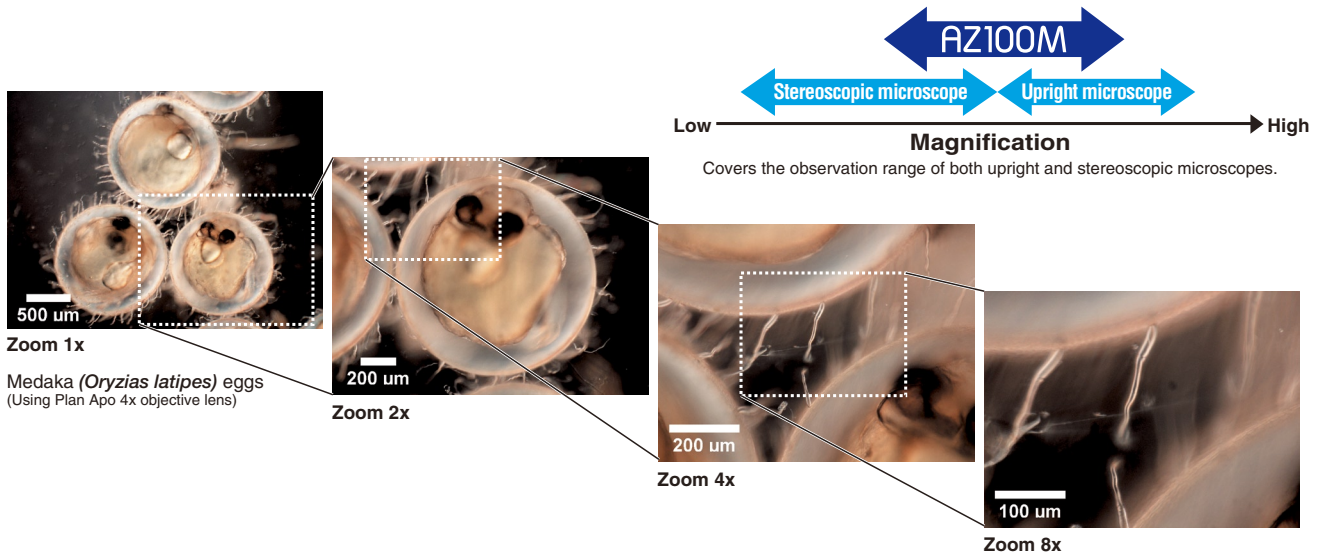

Non-angled, on-axis images

Since stereoscopic microscopes obtain three-dimensional images using binocular vision, monocular images are angled in either direction. Therefore, images taken with a camera will be off-axis. However, the AZ100M acquires images that are on-axis, similar to those taken with an upright microscope. It is ideal for creating all-in-focus EDF images of thick samples.

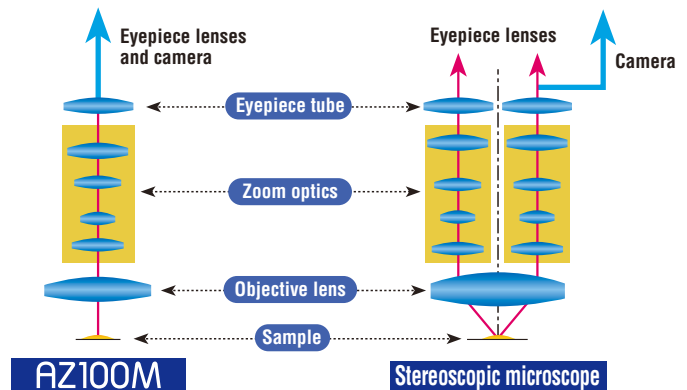
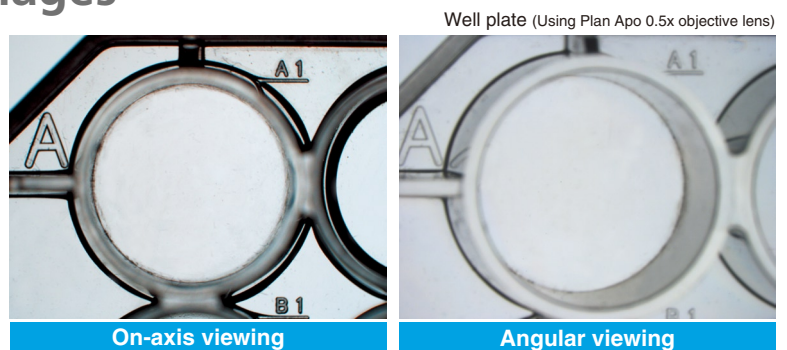

zoom microscopes

Comes standard with an aperture stop

The AZ100M includes a built-in aperture stop that allows you to easily control contrast and the depth of field, both visually and on your digital images.

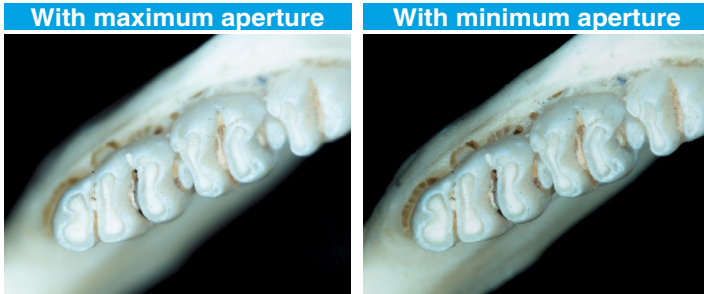

Aperture stop dial

Rat jaw
(Using Plan Apo 0.5x objective lens)

Various microscopy methods

Brightfield and a wide range of other observation methods are possible, including epi-fluorescence, Nomarski DIC, simple polarizing, and oblique illumination. The AZ100M enables the simultaneous combination of epi-fluorescence and diasopic DIC attachments, which allows for quick and convenient switching between observation modes.

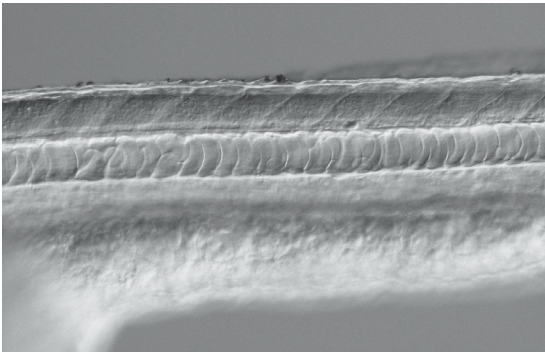

Diasopic DIC
Zebrafish (Using Plan Fluor 5x objective lens)



Ring LED illumination
Rat skull base
(Using Plan Apo 0.5x objective lens)



Oblique illumination
Anchovy otolith
(Using Plan Fluor 5x objective lens)

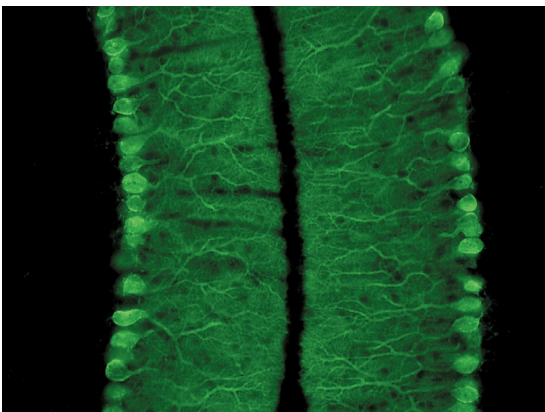

Epi-fluorescence
Mouse cerebellum (Using Plan Apo 4x objective lens)

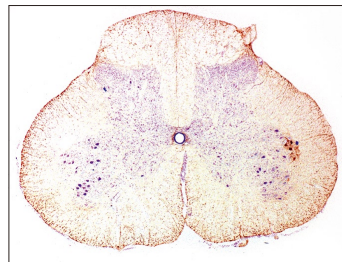

Diasopic brightfield
Rat spinal cord
(Using Plan Apo 1x objective lens)

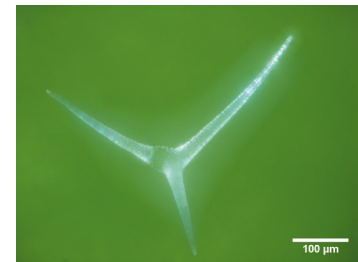

Episcopic brightfield
Trichome of *Arabidopsis thaliana*

AZ100M ZOOM

PC-operated, from microscope — When used with NIS-Elements

Using the AZ100M with Nikon's NIS-Elements imaging and analysis on a PC, in addition to basic operations su



Create EDF (Extended Depth of Focus) images of thick samples

By controlling the Z-axis movement of the AZ100M with the NIS-Elements imaging software, you can capture a series of images with different focal planes. Then, simply combine them to create a single image that is completely in focus.

*Requires EDF plug-in software.

Different Z-axis images taken with motorized focus

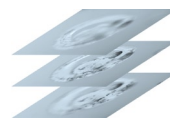
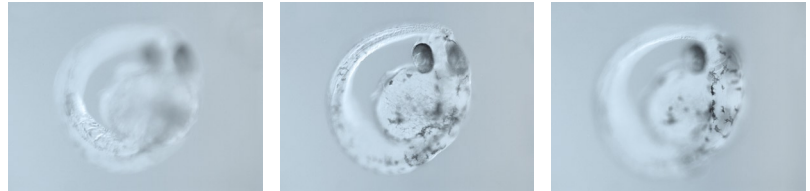

NIS-Elements creates a synthesized image of the portions in focus.



All-in-focus image Zebrafish embryo (Using Plan Fluor 5x objective lens)

Control to image capture and processing imaging software

software enables image capture and sophisticated image processing
such as focusing and zooming.

The scale bar is displayed in conjunction with magnification changes

When a Digital Sight camera is attached, the scale bar, which is linked to the objective lens magnification and variations in zoom, changes automatically. You can save the scale with the image.

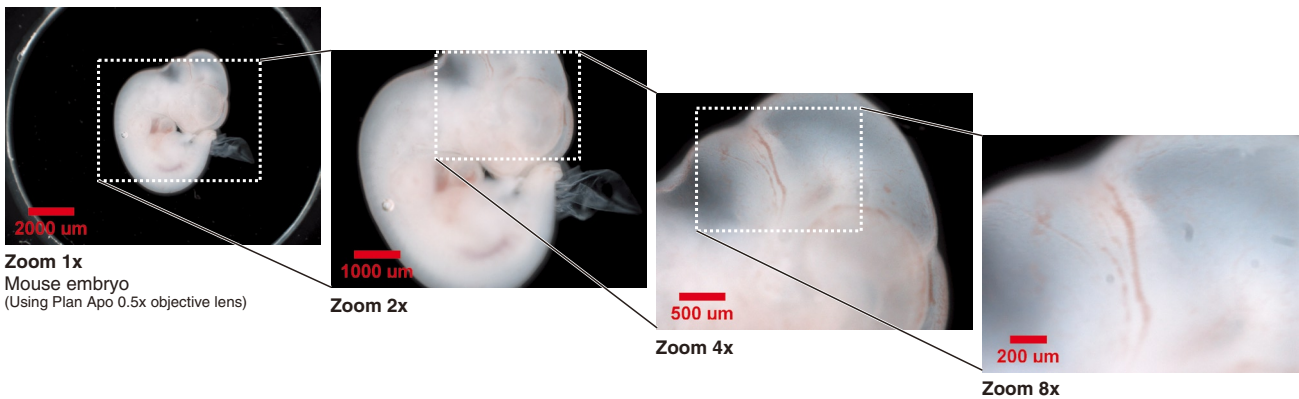

AZ100M + DS-Fi2-U3 + NIS-Elements

When used with NIS-Elements imaging software

The microscope and camera are synced together to enhance automated imaging acquisition and ease of use.

- Creating EDF images
- Auto-record microscope status data with images
- Display a scale that reflects the observation magnification
- Operate the microscope and camera from a PC

Microscope control GUI

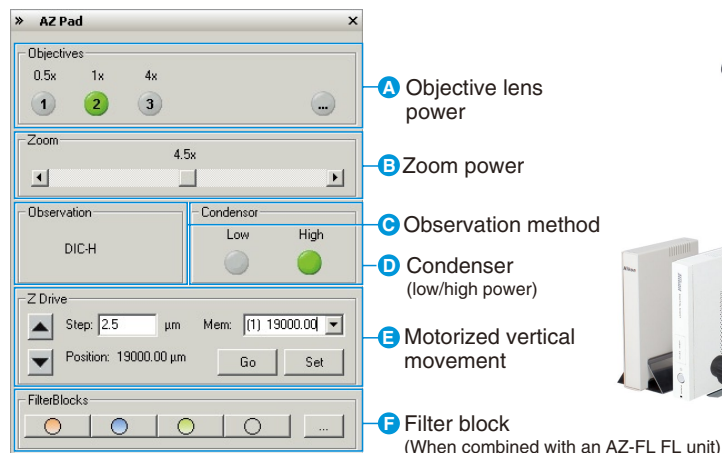

Simple image capturing without a PC

— Combined with a Digital Sight series digital camera DS-Fi2-L3

AZ100M + DS-Fi2-L3

Combined with the DS-L3 standalone control unit

The camera automatically detects microscope status data.

- Display a scale reflecting the observation magnification
- Auto-record microscope status data with images
- Operate the microscope and camera from the controller

■ GUI for intuitive operation ■

The DS-L3's icon-based menu screens offer excellent recognizability. From image acquisition to setting of shooting parameters, measurement, and export of image data, all operations can be performed easily by touching the screen.

Main menu/
Tool menu GUI



High-definition touch panel monitor

Built-in 8.4" 1024×768 monitor. Easy to see and easy to use, the large touch-panel monitor allows simple setting and operation of the camera head with a touch of a finger or stylus.

A wide variety of tools

The DS-L3 enables the conducting of simple measurements on images, with input of lines and comments. These can also be written onto and saved with the image, and measurement data can be output.

Measurement function

- Measurement [2 point distance, Point to line distance, Circle distance, Angle, Circle (Diameter, Radius), Area, Pitch distance]

Position and size comparison functions

- Scale indication • Cross-hairs • Grid • XY scale • XY measurement

Drawing functions

- Count marking • Text input • Pen drawing (Straight line, Curved line)

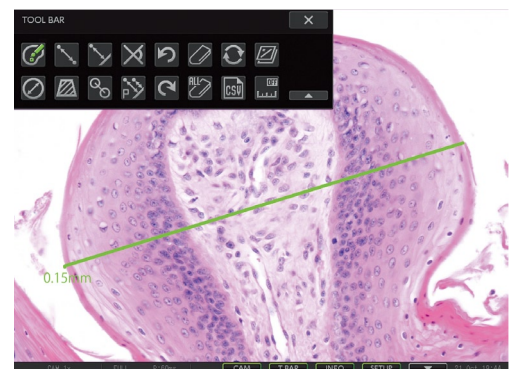

Measurement (2 point distance)

A microscopy image capture system worthy of the Nikon name

Digital Sight series digital camera system

A flexible system that enables various configurations consisting of a camera head and a control unit to suit the needs of any sample or application.

Camera Heads



High-definition color camera head **DS-Fi2**

5-megapixel high-definition color. The DS-Fi2 offers advanced performance, including a wide dynamic range and superior red sensitivity, and is optimal for brightfield, darkfield, phase contrast, and DIC image capture.

*See the Digital Sight series catalog for more information.



High-sensitivity cooled monochrome camera head **DS-Fi1c**

The DS-Fi1c is equipped with a 5.0-megapixel color CCD and Peltier element capable of cooling to a -20°C ambient temperature. Even in fluorescent image shooting requiring long exposure times, high-contrast images can be obtained with limited thermal background noise.

*See the Digital Sight series catalog for more information.

Control Units



Standalone control unit **DS-L3**

Equipped with a large touch panel monitor and a rich feature set, the DS-L3's ease of operation enables quick image acquisition even without a PC or computer monitor.

■ Scene mode ■

Optimal camera settings have been preprogrammed for each observation method and are selectable from the menu.



Darkfield/
Fluorescence



Brightfield



DIC/PH



HE



ELISA



PC-use control unit **DS-U3**

From display and shooting of live images to advanced image processing and analysis, the DS-U3 allows the control of all functions from a PC and is flexibly adaptable to a wide range of applications.



Imaging software **NIS-Elements** **D**

Standard software for a combination of the AZ100M and DS-U3. It supports the simple acquisition requirements of color documentation, with basic measuring and reporting capabilities. Adding the EDF plug-in software (see p.6) allows you to operate the microscope and camera in synchronization, easily creating all-in-focus images. The following optional packages are also available for even more sophisticated research applications.



For most advanced research applications supports up to 6D (X, Y, Z, T, Wavelength, Multipoint) acquisition.



Supports up to 4D (such as X,Y,Z,T and X,Y, Z, Wavelength) acquisition.

*See the NIS-Elements catalog for more information.

Comprehensive line-up of accessories

Eyepiece tubes

The lineup includes the ergonomic tilting trinocular eyepiece tubes AZ-TE100 (beam-split ratio 100:0/0:100) and AZ-TE80 (beam-split ratio 100:0/20:80), as well as the vertical monocular tube (AZ-TP 0.6x). The 0.6x reduction optics built into photo port enable capturing of images with a wider field of view.

*Accepts ISO type C-mount Direct CCTV Adapters.



- 1 AZ-TE100 Ergonomic Trinocular Tube 100
- 2 AZ-TE80 Ergonomic Trinocular Tube 80
- 3 AZ-TP DSC Tube 0.6x

The AZ100M comes standard with tilting trinocular eyepiece tubes that tilt from 0° to 30° to allow the optimal eye level for the observer's height and posture. Two different beamsplit ratios for the binocular and photo port can be selected: the 100:0/0:100 type, which is optimal for photo documentation, or the 100:0/20:80 type, which enables visual observation while displaying an image on a monitor.

Diascopic stand/Diascopic stage

Combining a variety of holders with a diascopic illumination stand and a stage makes various observation methods possible, including brightfield, Nomarski DIC, simple polarizing for everything from large samples to Petri dishes and glass slides.



- 1 AZ-STD Motorized Focusing Diascopic Stand
- 2 AZ-STGD DIA Stage
- 3 AZ-SG Stage Glass

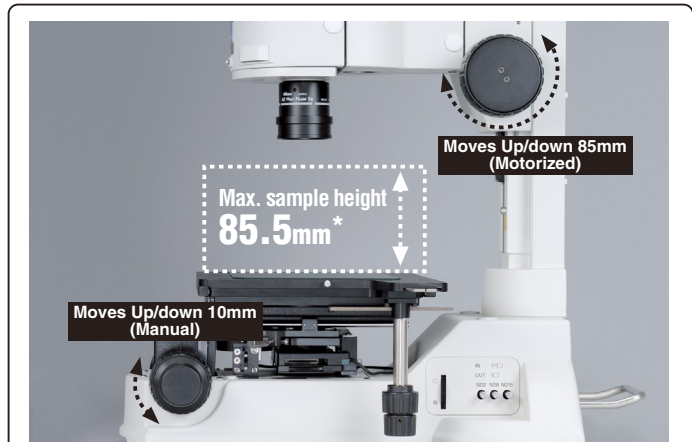

The AZ100M stand combines motorized focus (stroke: 85mm) on the column side, and a comfortably operated manual focus conveniently located on the front stage side (stroke: 10mm), enabling observation of samples with a height up to a maximum of 85.5mm*. In addition, since the objective lens has long working distances, Petri dish observation is also possible.

*Differs according to the combination with objective lens.



- 1 AZ-SDA Dish Holder Adapter
- 2 AZ-SRP Rotatable Plate



- 1 Thermo Plate MATS-U505S (TOKAI HIT Co., Ltd.)
- 2 AZ-STA Thermo Plate Adapter

Requires AZ-SDA dish holder adapter or AZ-SRP Rotatable Plate.



- 1 ø35mm Petri dish holder
- 2 Hemacytometer holder
- 3 C-HU Universal holder
- 4 C-HSG Slide glass holder
- 5 C-HT Terasaki holder

Objective lenses

Nikon has developed new dedicated objective lenses with a high NA and low distortion. There are five lens types, each of which are capable of multiple illumination techniques.



1 AZ-Plan Apo 0.5x 2 AZ-Plan Apo 1x 3 AZ-Plan Fluor 2x 4 AZ-Plan Apo 4x 5 AZ-Plan Fluor 5x

Objective lens specifications

	Plan Apo 0.5x	Plan Apo 1x	Plan Fluor 2x	Plan Apo 4x	Plan Fluor 5x (include correction ring)
	Parfocal				
WD	54mm	35mm	45mm	20mm	15mm
NA	0.05	0.1	0.2	0.4	0.5
DIC	—	EPI/DIA	—	EPI/DIA	EPI/DIA
Epi-fluorescence	○	○	○ (UV excitation possible)	○	○ (UV excitation possible)
LED illumination	○	○	—	—	—
Coaxial illumination	○ (with lambda plate)	○ (with lambda plate)	—	○ (with lambda plate)	○ (with lambda plate)

Diascopic DIC attachments

Thanks to these newly developed DIC prisms, high-contrast DIC images with uniform coloration are possible at any magnification. (The objective lenses capable of DIC observation are the Plan Apo 1x, Plan Apo 4x, and Plan Fluor 5x.)

Note: The AZ-FLDIC FL-DIC Prism Holder is required to simultaneously mount this accessory along with the AZ-FL epi-Fluorescence Attachment.



1 AZ-DPS1 DIA DIC Prism Slider 1-4x 5 AZ-DP4 DIA DIC Prism 4x
2 AZ-DPS5 DIA DIC Prism Slider 5x 6 AZ-DP5 DIA DIC Prism 5x
3 AZ-AN DIA DIC Prism Holder with Analyzer 7 AZ-RP Rotatable Polarizer
4 AZ-DP1 DIA DIC Prism 1x 8 AZ-DL DIA DIC Lambda Plate

Epi-fluorescence attachments

Since the excitation light path of the AZ100M is separated from the observation optics, fluorescence images with high S/N ratio can be obtained, without being affected by the zoom optics. The newly developed Intensilight mercury pre-centered fiber illuminator minimizes thermal effects on the microscope itself, and there is no need for troublesome lamp-centering adjustment.



Note: For UV excitation, the lamp-housing type mercury lamp (5) is recommended.



1 C-HGFI/HGFIE HG Precentered Fiber Illuminator (130W), HG Fiber
2 AZ-FL Epi-Fluorescence Attachment
3 AZ-HGFA Fiber Adapter
4 Fluorescence Filter Cubes
5 C-SHG1 Starter 100W, Lamphouse HMX-4B, AZ-HGA HG Lamphouse Adapter

Episcopic DIC attachments



1 C-FI115/230 Fiber Illuminator 5 AZ-EL EPI DIC Lambda Plate
2 AZ-ICI Coaxial Episcopic Illuminator 6 AZ-EPS1 EPI DIC Prism Slider 1-4x
3 YM-ND25 ND4/ND16 7 AZ-EPS5 EPI DIC Prism Slider 5x
4 AZ-NCB NCB Filter for Coaxial Epi Illuminator 8 AZ-PH EPI DIC Prism Holder



Lamphouse configuration

LED illuminator

This high-intensity reflected illuminator features a long-life white LED. It includes an intensity control function that provides stable and even illumination.

*Can be used with the Plan Apo 0.5x and Plan Apo 1x objective lenses



AZ-LED LED Ring Illuminator



Coaxial illuminator

This illuminator is ideal for observation of flat, perpendicular mirror-surface samples.

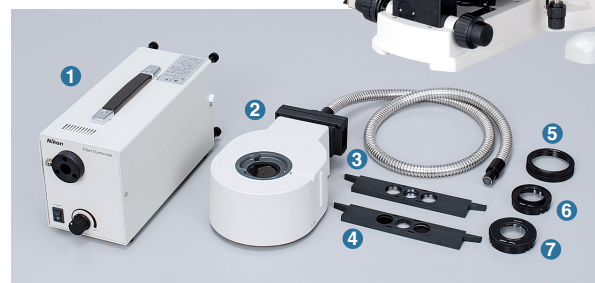

- 1 C-FI115/230 Fiber Illuminator
- 2 AZ-ICI Coaxial Episcopic Illuminator
- 3 AZ-NCB NCB Filter
- 4 YM-ND25 ND4/ND16
- 5 AZ-QLL ICI 1/4 Lambda Plate 0.5x
- 6 AZ-QLM ICI 1/4 Lambda Plate 1x
- 7 AZ-QLH ICI 1/4 Lambda Plate 4-5x



Oblique illumination slider

By inserting the sliding diaphragm at a conjugated position with the objective pupil, the center of the light beam is blocked allowing coherent light to be projected obliquely onto the sample. This allows observation of transparent colorless samples by applying relief-like contrast.

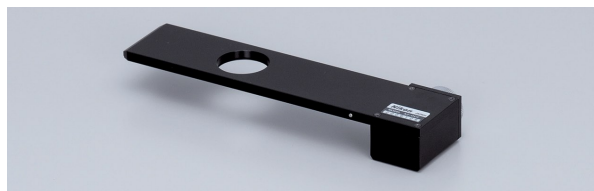

AZ-OI Oblique Illumination Slider

Diascopic simple polarizing attachments

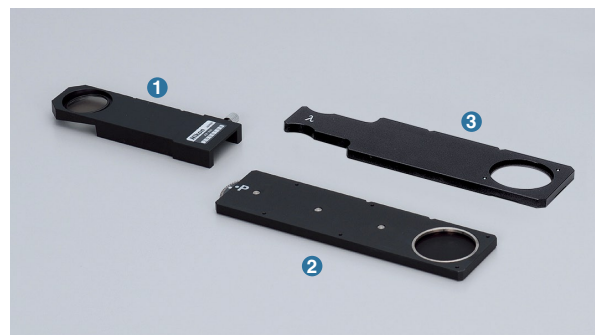

- 1 AZ-AN Analyzer
- 2 AZ-RP Rotatable Polarizer
- 3 AZ-DL DIA DIC Lambda Plate

Foot controllers

Motorized focusing and zoom adjustment via foot pedal is possible through AZ-FSW Foot Switch. Nikon also offers the AZ-PCR Photo Release for foot-operation of the DS-L2 camera controller. These controllers are especially handy when both hands are busy with the sample or the microscope.

*The foot switch cannot be used when NIS-Elements is running



- 1 AZ-FSW Foot Switch
- 2 AZ-PCR Photo Release

Specifications/Dimensions

Total magnification	5x to 400x (depends on the combination of eyepiece lenses and objective lens), 6.25x to 500x when a coaxial illuminator is mounted
Zoom range	1 to 8 (zoom ratio: 8:1, motorized variable power zoom)
Eyepiece tubes	AZ-TE100 Ergonomic Trinocular Tube 100 (beamsplit ratio 100:0/0:100, 0.6x reduction optics built into photo port) AZ-TE80 Ergonomic Trinocular Tube 80 (beamsplit ratio 100:0/20:80, 0.6x reduction optics built into photo port) AZ-TP DSC Tube 0.6x (direct tube type, 0.6x reduction optics built in)
Inclination angle	0 to 30 degrees (eyepiece tube AZ-TE100/AZ-TE80)
Interpupillary adjustment range	50 to 75mm (eyepiece tube AZ-TE100/AZ-TE80)
Eyepiece lens	AZ-W10x eyepiece 10x (FOV: 22mm)
Focus mount adapters	AZ-FM AZ Focusing Mount Adapter
Stands	AZ-STD Motorized Focusing Diascopic Stand (Focus mount section: 85mm stroke, motorized vertical movement, Note: Manual operation is not possible while power is on.)
Stages	AZ-STGD DIA Stage (150 x 100mm stroke)
Objective lens mounts	AZ-NPI Triple Nosepiece I, AZ-NPS Single Nosepiece
Objective lenses	AZ-Plan Apo 0.5x (NA: 0.05/WD: 54mm), AZ-Plan Apo 1x (NA: 0.1/WD: 35mm) AZ-Plan Fluor 2x (NA: 0.2/WD: 45mm), AZ-Plan Apo 4x (NA: 0.4/WD: 20mm) AZ-Plan Fluor 5x (NA: 0.5/WD: 15mm)
Illuminators	C-FI115/230 Fiber Illuminator for transmitted light observation, AZ-ICI Coaxial Episcopic Illuminator (C-FI115/230 Fiber Illuminator: 12V 100W halogen lamp, device magnification: 1.25x) AZ-LED LED Ring Illuminator
Epi-fluorescence attachment	AZ-FL Epi-fluorescence Attachment (up to four filter cubes mountable) AZ-FLDIC FL-DIC Prism Holder (Use when simultaneously mounting epi-fluorescence and diascopic DIC attachments.)
Light source for epi-fluorescence observation	C-HGFI HG Precentered Fiber Illuminator (130W mercury lamp), C-HGFIE HG Precentered Fiber Illuminator (motorized; 130W mercury lamp), Lamphouse HMX-4B (100W mercury lamp)
Observation methods	Transmitted light: brightfield, Nomarski DIC, simple polarizing, and oblique illumination observation Reflected light: fluorescence, Nomarski DIC, coaxial illumination, and LED illumination observation
Weight	Epi-fluorescence + diascopic DIC configuration: (when using AZ-STD Motorized Focusing Diascopic Stand): approx.33kg

Epi-fluorescence + DIC configuration

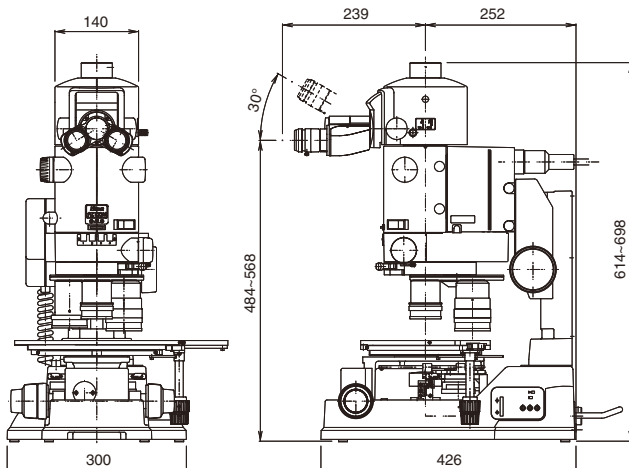

DIC configuration

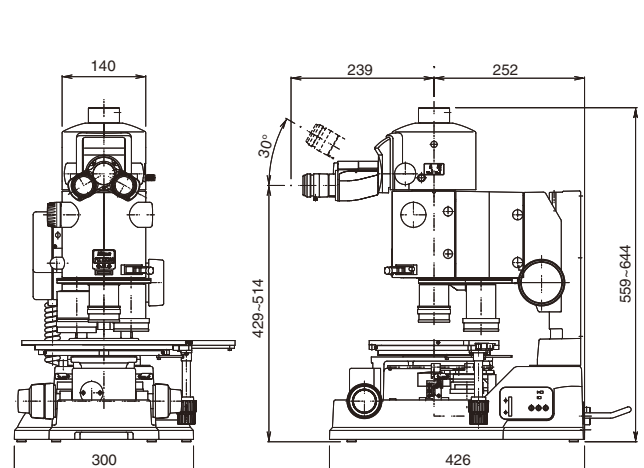

System Diagram

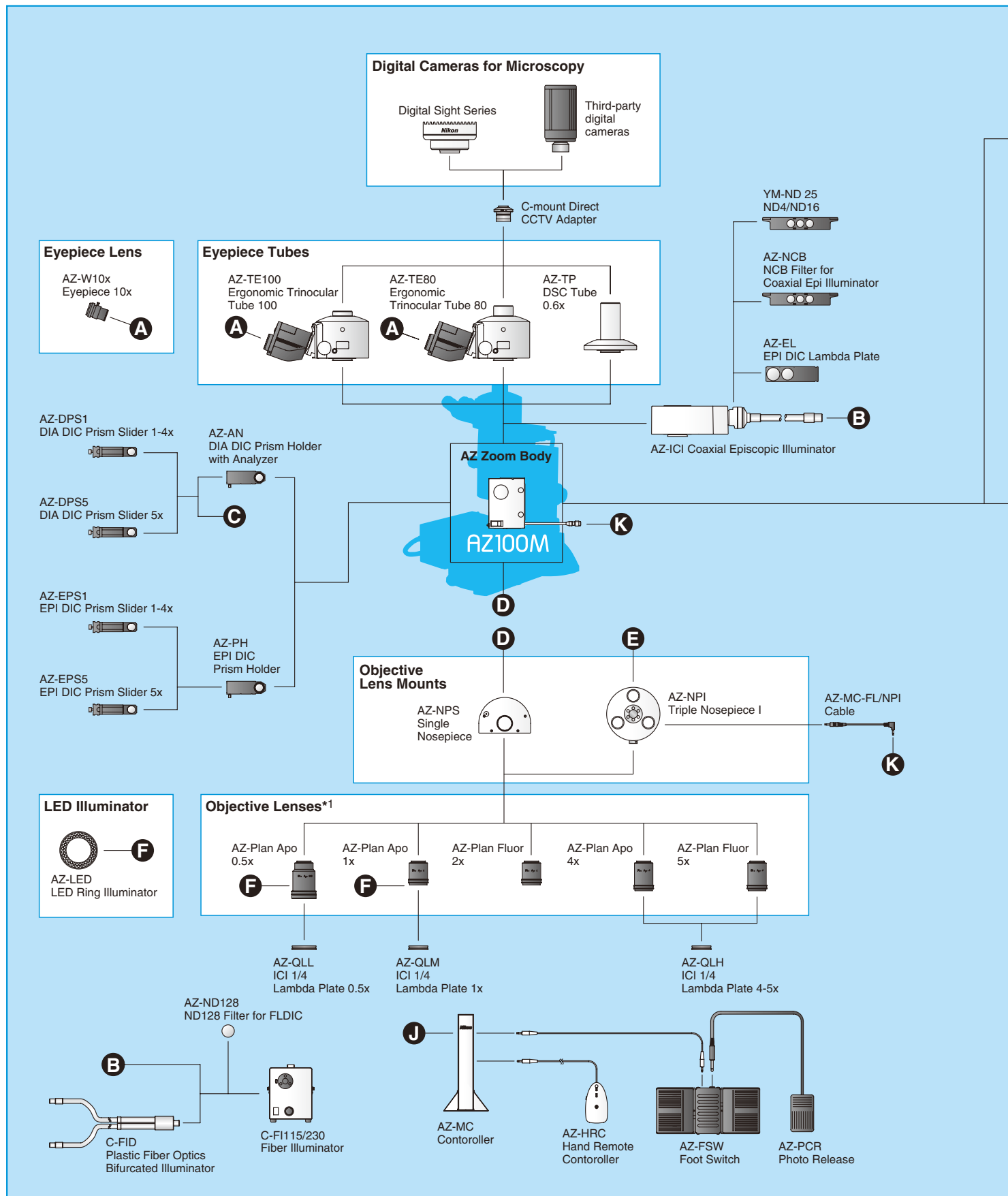

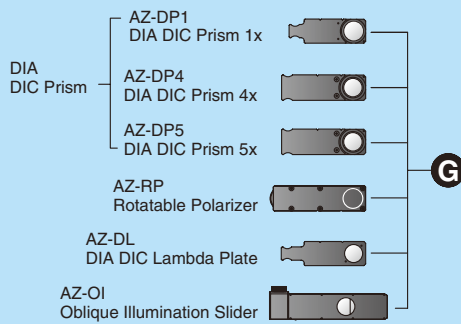
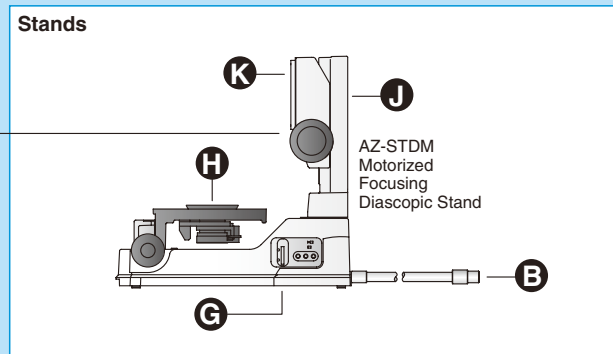
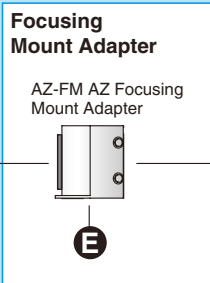
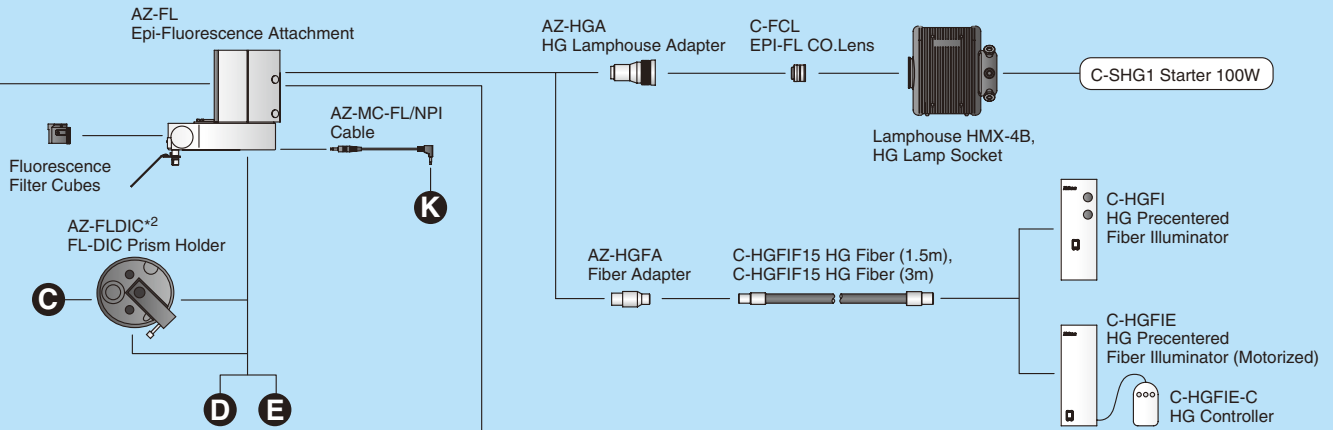

Stages/Holders

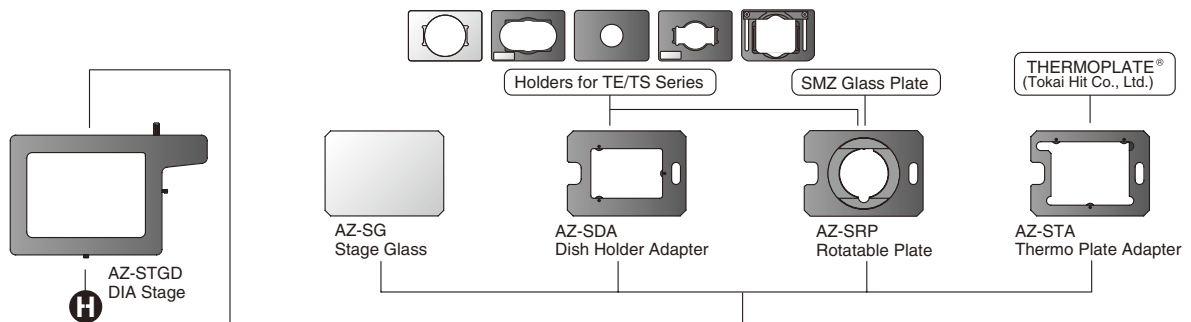

*1 See page 11 regarding combinations with illuminators. *2 Use when simultaneously mounting epi-fluorescence and diascope DIC attachments. *3 Combination with coaxial illuminator is not possible.

Samples provided by:

Tetsuo Sugimoto, Professor, Department of Anatomy and Brain Science, Faculty of Medicine, Kansai Medical University (front cover, top of page 5, No.2 and No.5 on page 5)
Shoji Oda, Ph.D., Lecturer, Laboratory of Genome Stability, Department of Integrated Bioscience, Graduate School of Frontier Science, University of Tokyo (page 3 and top of page 4)
Hitoshi Okamoto, MD, Ph.D., Lab. Head, and Hideomi Tanaka, Ph.D., Brain Science Institute, RIKEN (No.1 on page 5)
Teiichi Furuichi, Ph.D., Lab. Head, and Noriyuki Morita, Ph.D., Brain Science Institute, RIKEN (No.4 on page 5)
Youichi Tsukamoto, Ph.D., Section Chief, Fisheries Biology Section, East China Sea Fisheries Resources Division, Seikai National Fisheries Research Institute (No.3 on page 5)
Shin-ichi Arimura, Assistant Professor, Graduate School of Agricultural and Life Sciences, University of Tokyo (No.6 on page 5)
Touru Murakami, Ph.D., Lecturer, Neuromuscular and Developmental Anatomy, Graduate School of Medicine, Gunma University (page 6)
Masayuki Sekiguchi, Ph.D., Section Chief, Department of Degenerative Neurological Diseases, National Institute of Neuroscience, National Center of Neurology and Psychiatry, Japan (page 7)

Specifications and equipment are subject to change without any notice or obligation on the part of the manufacturer. March 2015 ©2007-2015 NIKON CORPORATION

N.B. Export of the products* in this catalog is controlled under the Japanese Foreign Exchange and Foreign Trade Law. Appropriate export procedures shall be required in case of export from Japan.

*Products: Hardware and its technical information (including software)



WARNING

TO ENSURE CORRECT USAGE, READ THE CORRESPONDING MANUALS CAREFULLY BEFORE USING THE EQUIPMENT.



NIKON CORPORATION

Shinagawa Intercity Tower C, 2-15-3,
Konan, Minato-ku, Tokyo 108-6290, Japan
phone: +81-3-6433-3705 fax: +81-3-6433-3785
<http://www.nikon.com/instruments/>



ISO 9001 Certified
for NIKON CORPORATION
Microscope Solutions Business Unit
Industrial Metrology Business Unit

ISO 14001 Certified
for NIKON CORPORATION

NIKON INSTRUMENTS INC.

1300 Walt Whitman Road, Melville, N.Y. 11747-3064, U.S.A.
phone: +1-631-547-8500; +1-800-52-NIKON (within the U.S.A. only)
fax: +1-631-547-0306

<http://www.nikoninstruments.com/>

NIKON INSTRUMENTS EUROPE B.V.

Tripolis 100, Burgenweeshuispad 101, 1076 ER Amsterdam, The Netherlands
phone: +31-20-7099-000 fax: +31-20-7099-298
<http://www.nikoninstruments.eu/>

NIKON INSTRUMENTS (SHANGHAI) CO., LTD.

CHINA phone: +86-21-6841-2050 fax: +86-21-6841-2060
(Beijing branch) phone: +86-10-5831-2028 fax: +86-10-5831-2026
(Guangzhou branch) phone: +86-20-3882-0550 fax: +86-20-3882-0580

NIKON SINGAPORE PTE LTD.

SINGAPORE phone: +65-6559-3651 fax: +65-6559-3668

NIKON INSTRUMENTS KOREA CO., LTD.

KOREA phone: +82-2-2186-8400 fax: +82-2-555-4415

NIKON CANADA INC.

CANADA phone: +1-905-602-9676 fax: +1-905-602-9953

NIKON FRANCE S.A.S.

FRANCE phone: +33-1-4516-45-16 fax: +33-1-4516-45-55

NIKON GMBH

GERMANY phone: +49-211-941-42-20 fax: +49-211-941-43-22

NIKON INSTRUMENTS S.p.A.

ITALY phone: +39-55-300-96-01 fax: +39-055-30-09-93

NIKON AG

SWITZERLAND phone: +41-43-277-28-67 fax: +41-43-277-28-61

NIKON UK LTD.

UNITED KINGDOM phone: +44-208-247-1717 fax: +44-208-541-4584

NIKON GMBH AUSTRIA

AUSTRIA phone: +43-1-972-6111-00 fax: +43-1-972-6111-40

NIKON BELUX

BELGIUM phone: +32-2-705-56-65 fax: +32-2-726-66-45